

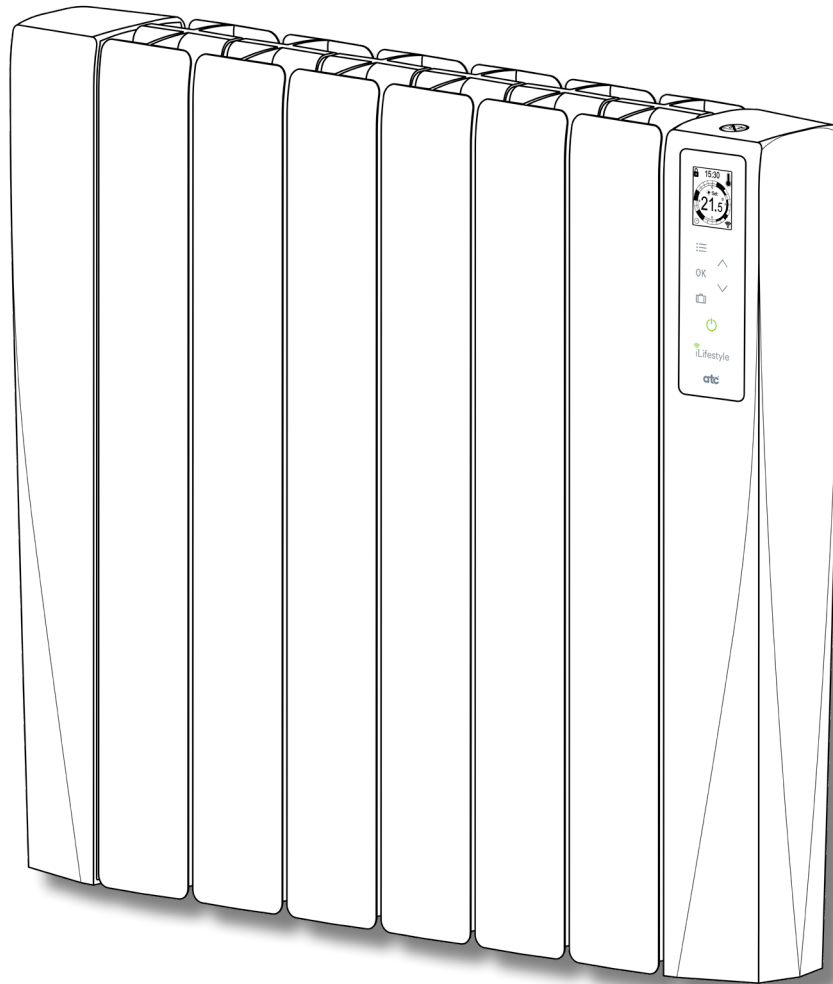

iLifestyle

Wifi smart fluid electric thermal radiator



A73023523 - Rev. 00 - 2025-06

THIS PAGE INTENTIONALLY LEFT BLANK

IMPORTANT

- WARNING: In order to avoid overheating, do not cover the heater. The appliance itself is marked with the standard “Do not cover” symbol.
- 
- Do not sit on the appliance.
 - This appliance is not intended for outdoor use.
 - This appliance can be used by children aged 8 years and above and persons with reduced physical, sensory or mental capabilities or lack of experience and knowledge, if they have been given appropriate supervision or training regarding the use of the appliance in a safe way and they understand the dangers involved. Children must not play with the appliance. Cleaning and maintenance to be performed by the user must not be performed by children without supervision.
 - Children under 3 years should be kept out of the reach of the appliance unless they are constantly supervised.
 - Children from 3 years and under 8 years should only turn on/off the appliance provided that it has been placed or installed at its intended normal operating position and that they are supervised or have received instructions concerning use of the appliance safely and understand the risks that the appliance has. Children from 3 years and under 8 years should not plug in, regulate and clean the appliance or perform maintenance operations.
 - **CAUTION - Some parts of this product can become very hot and cause burns. Particular attention must be paid when children and vulnerable people are present.**

- The heater must not be located immediately below a socket-outlet.
- This heater is filled with a precise quantity of special oil. Repairs requiring opening of the oil container are only to be made by the manufacturer or his service agent who should be contacted if there is an oil leakage.
- When scrapping the heater, ensure it is recycled responsibly and follow the regulations concerning the disposal of oil.
- The heater must be installed so that around it there is sufficient space for correct circulation of hot air, always respecting the minimum distances indicated in the LOCATION section.
- The heater must be installed so that switches and other controls cannot be touched by a person in the bath or shower, respecting 0.6 m distance between the radiator and the bath or shower.
- **WARNING:** Means for disconnection must be incorporated in the fixed wiring in accordance with the wiring rules.
- If the supply cord is damaged, it must be replaced by the manufacturer, its service agent or similarly qualified persons in order to avoid a hazard.
- Mounting is an important part of safety. To perform the correct installation, go to MOUNTING section.
- Do not install radiator covers of any kind over the heater.
- Do not use this heater in the immediate surroundings of a bath, a shower or a swimming pool.
- Do not use this heater if it has been dropped.
- Do not use this heater if there are visible signs of damage to it.

- **WARNING:** Do not use this heater in small rooms when they are occupied by persons not capable of leaving the room on their own, unless constant supervision is provided.
- **WARNING:** To reduce the risk of fire, keep textiles, curtains or any other flammable material a minimum distance of 1 m from the air outlet.

CONTENTS

- 1 x ATC iLifestyle Wifi Smart Radiator
- 2 x Metal Brackets
- 2 x Plastic Covers (top)
- 2 x Locking Plastic Covers
- 4 x Grey Wall Plugs
- 4 x Hex-Head Fixings
- 1 x Instructions Manual
- 1 x Quick Start Guide
- 1 x Quick Start Guide for WiFi connection

Please contact sales@atc.ie if any of the above are missing.



DESIGNED AND MADE IN SPAIN

INDEX

1. INTRODUCTION	7
2. LOCATION	7
3. ELECTRICAL CONNECTION	8
4. MOUNTING	9
5. OPERATION	11
5.1 CONTROL PANEL	11
5.2 TURNING THE RADIATOR ON AND OFF	11
5.3 LINKING THE RADIATOR TO THE WiFi NETWORK	12
5.3.1 Radiator Registration and WiFi Network Linking Process	12
5.3.2 Setting up an account and registering the 1st radiator in the App.	13
5.3.2.1 Linking a radiator to a WiFi network	14
5.3.3 Control of the radiator through Virtual Assistants	15
5.3.4 WiFi Menu	15
5.3.4.1 WiFi Radiator Name	15
5.3.4.2 WiFi Radiator Code	15
5.3.4.3 Link WiFi	16
5.3.4.4 WiFi Network	17
5.3.4.5 WiFi Info	19
5.3.4.6 Firmware Update	19
5.4 SELECTING THE OPERATING MODE	20
5.4.1 COMFORT	21
5.4.2 ECONOMY	21
5.4.3 ANTI-FROST	21
5.4.4 PROGRAM	21
5.4.5 ENERGY Menu	23
5.4.5.1 Energy Meter Type	23
5.4.5.2 Rate	24
5.4.5.3 Reset	25
5.4.6 CONFIGURATION Menu	26
5.4.6.1 Brightness level at rest	26
5.4.6.2 Maximum brightness Time	27
5.4.6.3 Setting the time	27
5.4.6.4 Power Limitation	28
5.4.6.5 Open Window	28
5.4.6.6 Adaptive start control	28
5.4.6.7 Language	28
5.4.6.8 Currency	28
5.4.6.9 Reset factory defaults	29
5.5 HEATING AND TEMPERATURE DISPLAY	29
5.6 MANUAL MODE	29
5.7 OPEN WINDOW FUNCTION	30
5.8 ADAPTIVE START CONTROL FUNCTION	31
5.9 KEYBOARD LOCK	31
5.10 INTERNAL PARAMETERS CONFIGURATION	31
5.11 EASY MODE	33
6. ERROR CODE INFORMATION	34
7. MAINTENANCE AND CARE	35
8. CHARACTERISTICS TABLE	35
9. ECODESIGN TABLE	36
10. NOTES	36
11. CE DECLARATION OF CONFORMITY	37
12. UKCA DECLARATION OF CONFORMITY	38
13. WARRANTY	39
14. CORRECT DISPOSAL OF THIS PRODUCT	40

iLifestyle WiFi SMART FLUID ELECTRIC THERMAL RADIATOR

1. INTRODUCTION

Before switching the radiator on, carefully read these instructions which will help to ensure correct operation of the appliance.

Keep the instructions for future reference.

2. LOCATION

It is recommended to locate the radiator as close as possible to the coldest wall in the room. However, it is not recommended to install the radiator on external walls without any insulation. If it is necessary to mount on an uninsulated external wall the section of wall behind the thermal radiator must be insulated.

In bathrooms, the radiators must not be installed inside restricted areas. In the UK the radiator must be mounted outside Zone 2. In Ireland the radiator must be mounted outside Zone 3.

The control unit switches must not be reachable, directly or indirectly, by a person in the bath/shower or using the wash basin.

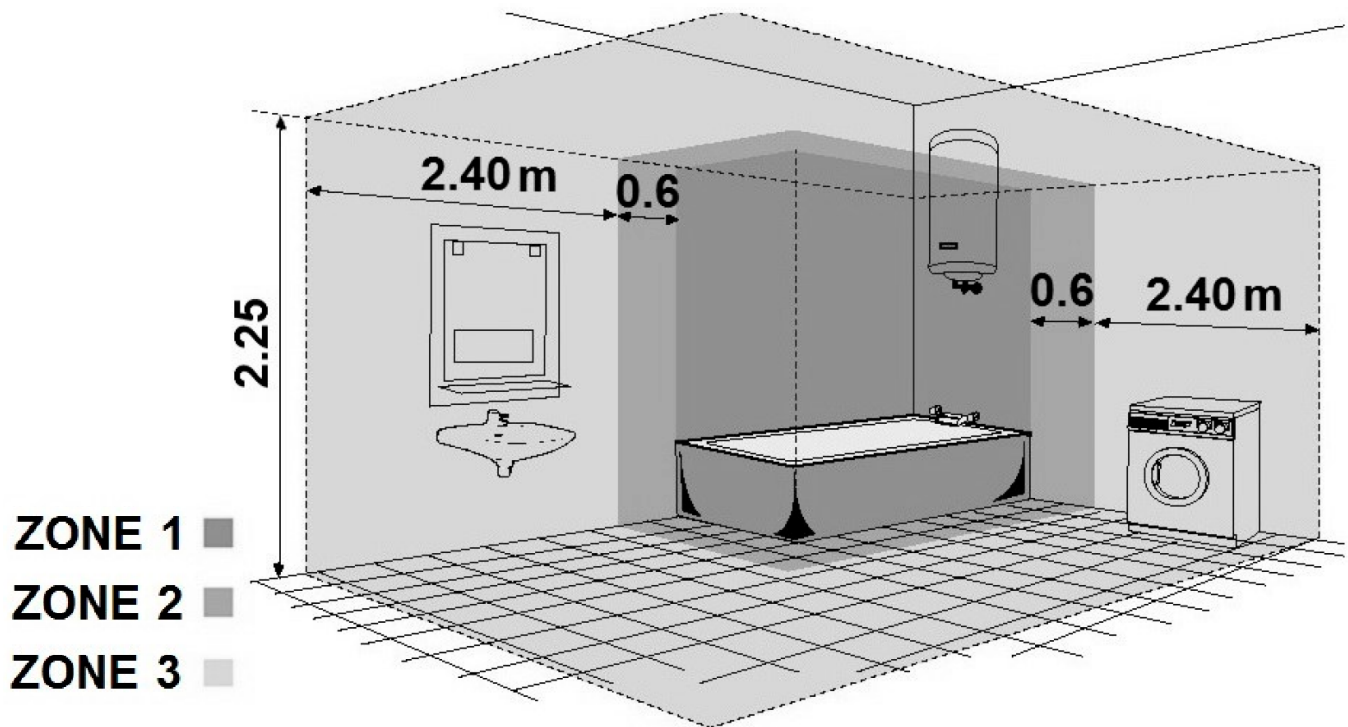

Classification of the bathroom zones

Under no circumstances may the thermal radiator be located below an electrical outlet.

Choose the location of the thermal radiator following the minimum distances indicated below:



Note: If the window sill protrudes less than 20 mm, the gap above the radiator can be disregarded.

3. ELECTRICAL CONNECTION

The iLifestyle WiFi radiator must be connected to the mains supply (230 V ~ 50 Hz.). It is required to install a switched spur for each radiator.

In addition, the following warnings must be taken into account:

- **The electric radiator must not be located underneath a light switch or any location where you need to stretch over the radiator to reach or operate the switch.**
- **The electrical supply circuit should be protected with a high sensitivity differential device (RCBO).**
- **It is necessary to isolate the power in the fixed wiring before installation.**

Connection wires:

Brown:	Live
Blue:	Neutral
Yellow-Green:	Earth

The connection wires must be of the appropriate cross section, with regard to the length and type of cable and the power rating of the radiator.

The radiator must be connected into a fused connection box fitted with an appropriate sized fuse for the radiator – see Technical Data on Page 35.

It is recommended that the connection box is positioned 10 cm to the right of the radiator and 15 cm above the floor.

According to regulations, the radiator must be connected to the power supply by means of an all-pole circuit breaker with a contact gap of at least 3 mm or by a thermal-magnetic circuit breaker. It is also recommended to install the radiators on a circuit protected by an RCBO.

4. **MOUNTING**

The electric radiator should be fixed to the wall by the adjustable width Metal brackets supplied with the radiator, using the cardboard template printed on the box.

If for any reason cardboard template is missing, please follow the instructions below:

1. Place the two metal brackets provided on the floor and against the wall as shown in Image 1 below. Ensure the MB stamp on the metal bracket is at the top.
2. Check Table 1 for the “A” distance between the brackets for your iLifestyle WiFi model.
3. Mark the small hole in the metal brackets on the wall with a pencil. These two marked points determine the position of the two lower drill holes.

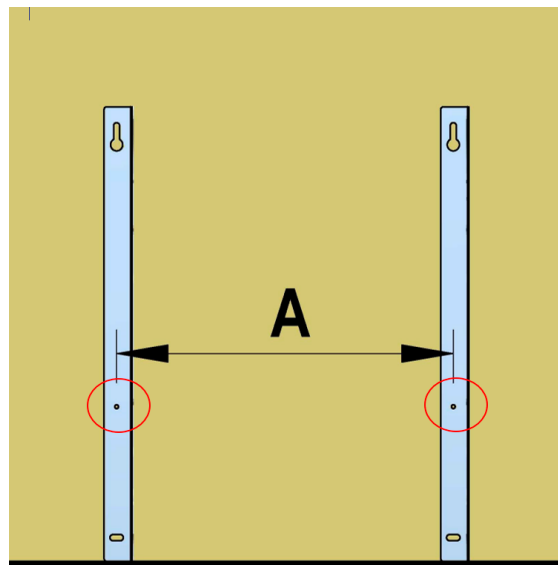
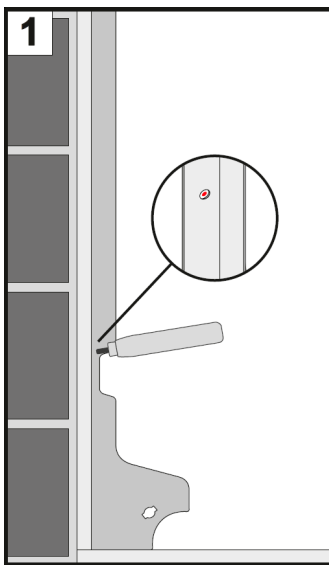

MODEL	A (mm)
WLS500	160
WLS750	240
WLS1000	320
WLS1200	400
WLS1500	560
WLS1800	720

Table 1

4. With the help of a level, position the brackets matching their lower holes with the previously marked points and mark the upper holes with the pencil.
5. Drill the 4 marked holes. The grey plugs supplied require an 8 mm hole.
6. Insert the grey plugs into the pre-drilled holes. Screw the metal brackets to the wall with the screws provided. See Image 2.

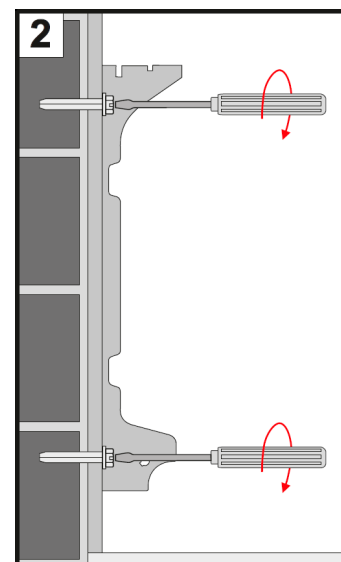
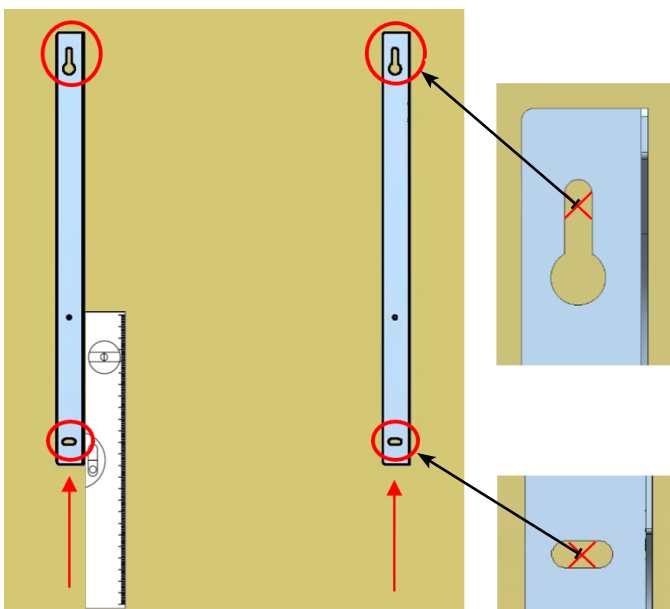

7. Attach the plastic pieces to the top and bottom of the metal brackets as shown in Images 3 and 4.

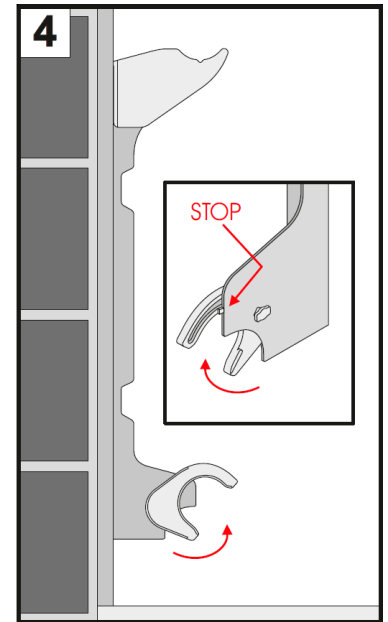
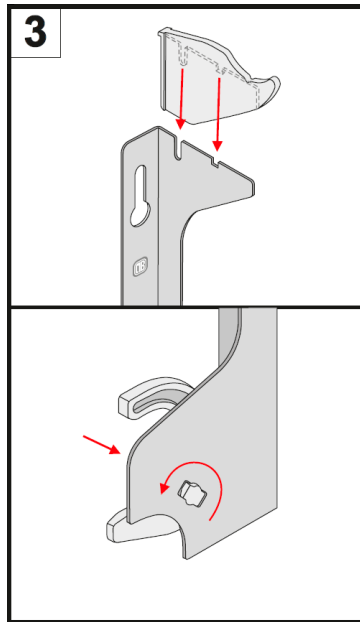

8. Hang the radiator as shown below and in Image 5.

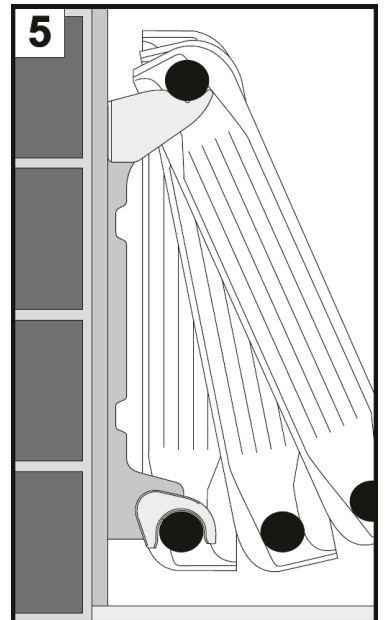
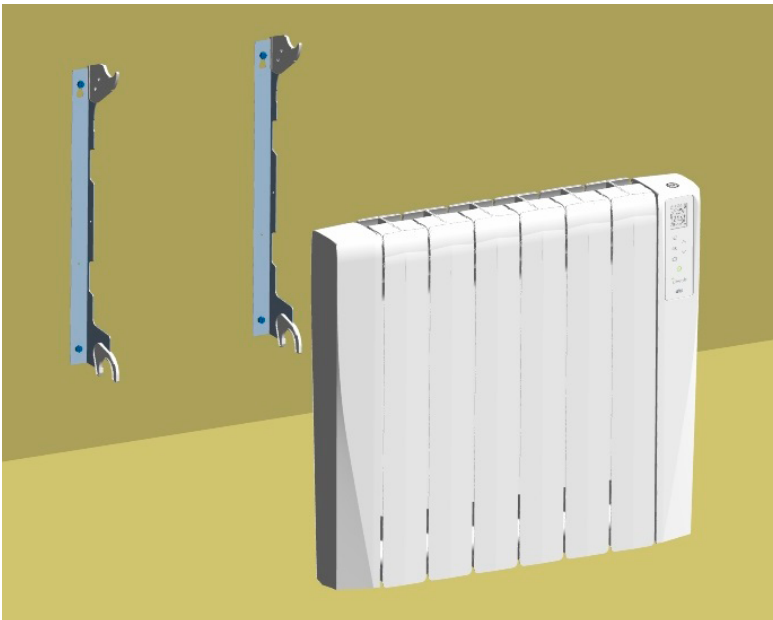

9. To detach the radiator from the bracket:

- 1) Push the plastic bracket away from the metal bracket
- 2) Lift the plastic bracket and pull the base of the radiator forward away from the metal bracket

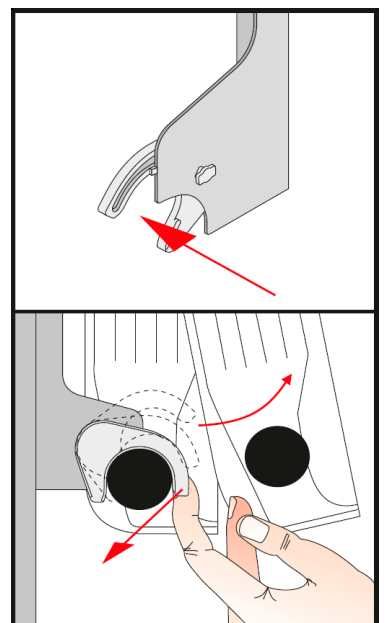

5. OPERATION

5.1 CONTROL PANEL

The control panel is made with a large TFT-LCD screen with white backlight and black images for ease of legibility. There are six touch sensitive keys, the functions are outlined below:

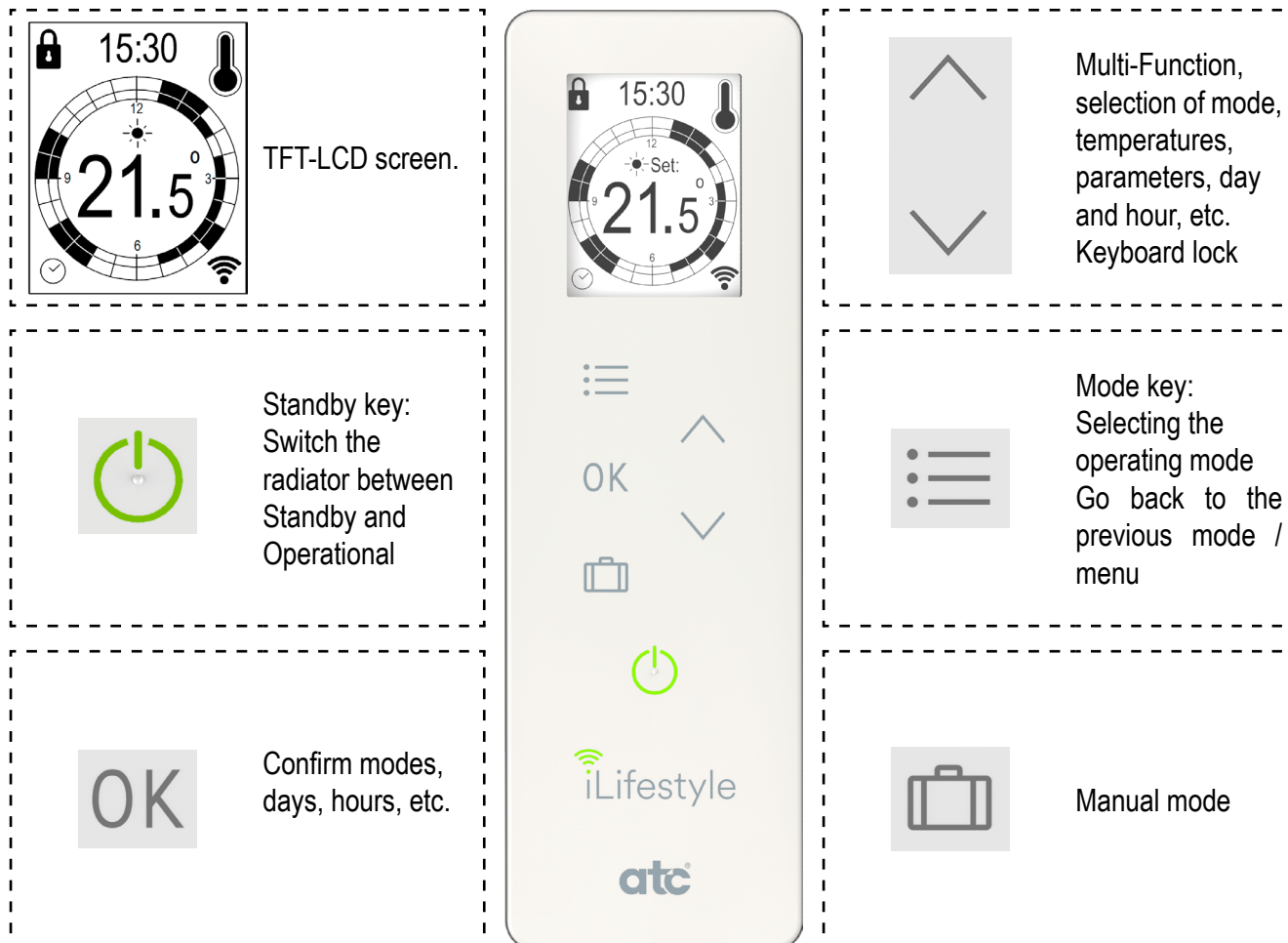

5.2 TURNING THE RADIATOR ON AND OFF

To switch the radiator on, it must be connected to the electrical supply (230 V ~ 50 Hz) as outlined in Section 3; the standby symbol or the current operating mode will appear on the screen. The radiator can be turned off or on by turning off or on the power at the fused spur outlet.

If the radiator is in Standby mode, to set it to Operational touch and hold the **Standby** key; a double beep will sound once the radiator is Operational.

The standby screen changes to show the welcome screen and then the radiator will start in the last operating mode.

From Operational, to configure the radiator in Standby mode, touch and hold the **Standby** key; there will be a long beep and the farewell screen will appear, just before going to the standby screen.

The back light will fade after 1.5 seconds.

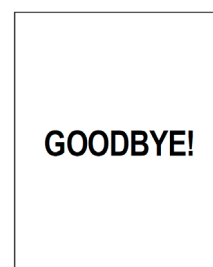

If any key is touched when the radiator is in Standby mode, there will be a short beep and the standby screen will appear. The radiator can be locked from Standby mode (see page 31 of this manual).

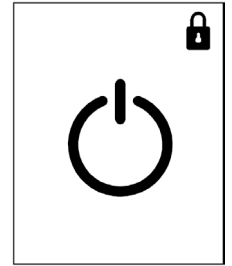

If there is a power failure or the radiator is disconnected, it will always remember the last operating mode, the temperature and the status (Standby / Operational and locked / unlocked).

The day and time will be saved when it is disconnected from the power supply for up to 10 years, depending on the button cell battery life (replacement cell CR2032). When the battery is depleted, and after power loss, the day and time must be re-entered, see page 27 of this manual for details.

If the battery is depleted and the iLifestyle WiFi radiator is linked to a WiFi Network *and is online* (i.e. router turned on and radiator is connected), the day and time of the radiator will always be automatically updated based on the radiator’s configured time zone (in the ATC CALA App).

IMPORTANT: For your safety it is recommended to use an electrician to replace the CR2032 coin cell once it is depleted.

Daily and weekly program and the WiFi Connection information, are never lost when disconnected from power for long periods.

5.3 LINKING THE RADIATOR TO THE WiFi NETWORK

The iLifestyle WiFi radiator has the option to be controlled remotely. In order to operate the iLifestyle Radiator remotely download the **ATC CALA** App.

Using the App, the iLifestyle WiFi radiator can be linked to a 2.4 GHz WiFi network.

Scan the QR code below to install the App on either **Android** or **iOS** devices.

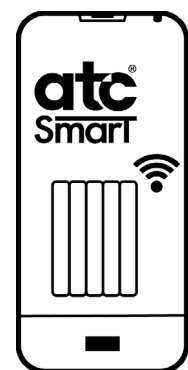

To manually install from either location, search for “**ATC CALA**”.

Once the App has been downloaded and installed, the Registration and WiFi Network Linking process can be carried out.

5.3.1 Radiator Registration and WiFi Network Linking Process

In order to control a radiator from a mobile device the following process must be completed:

- a) Sign up for an account using the Radiator code from the 1st radiator

b) Link the radiator to the WiFi network

Note: For the first iLifestyle WiFi radiator acquired, the process must always follow this order.

Once the App is setup and running, additional iLifestyle WiFi radiators can be set up or connected to WiFi in any order.

5.3.2 Setting up an account and registering the 1st radiator in the App.

Once the **ATC CALA** App is installed, register as a new user. Select **CREATE NEW ACCOUNT** from the initial Login screen and enter the following requested information.

User details:

- *Email address*, this will be used to access the App.
- *Password*, for login security (8 characters minimum).

iLifestyle WiFi Radiator details:

- *Radiator code*, identifies the specific radiator.
To access this information, touch the **Mode** key and select the information shown below with the arrows and the **OK** key:

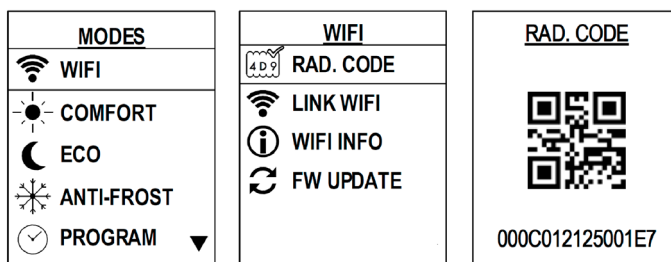

- *Radiator name*, enter a name to identify where the radiator is installed.
- *Installation name*, choose a name for the Installation.
Example: "FAMILY HOME"

Radiators must be added to an installation. Each installation can contain individual radiators or groups of radiators in a "zone". Each installation and the radiators assigned to it will have the same Time Zone, Currency and Energy Rate.

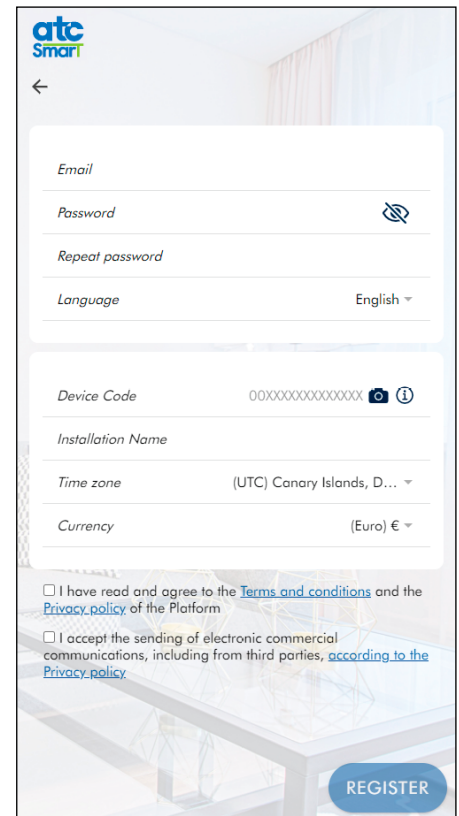

After clicking on **REGISTER**, the new user account will have been created and an email message sent with an Activation Code that will be required to Login.

To complete the account registration select **LOGIN** and fill in the email address and password. The App will then ask for the Activation Code, once this is completed the App will ask to link the Radiator to the local WiFi network.

NOTE: If the linking process is not completed at this time it can be completed later by touching the **WiFi Button** within the **Installations** Menu of the **ATC CALA** App.



Note: Once an account is created in the App, other iLifestyle WiFi radiators can be added by selecting the **+** button at any time.

5.3.2.1 Linking a radiator to a WiFi network

There are two steps in this process: 1st link the radiator directly to the mobile device, and 2nd Link the radiator to the local WiFi network.

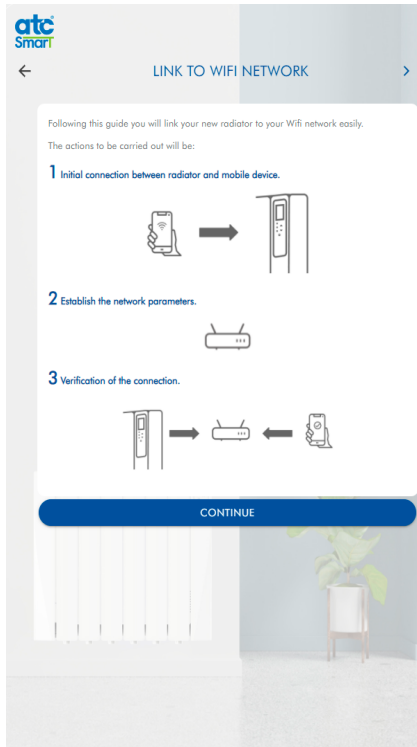

Once registered or when adding a radiator to the App, it will ask to link the radiator to the WiFi network. Touch **CONTINUE** to start the linking procedure.

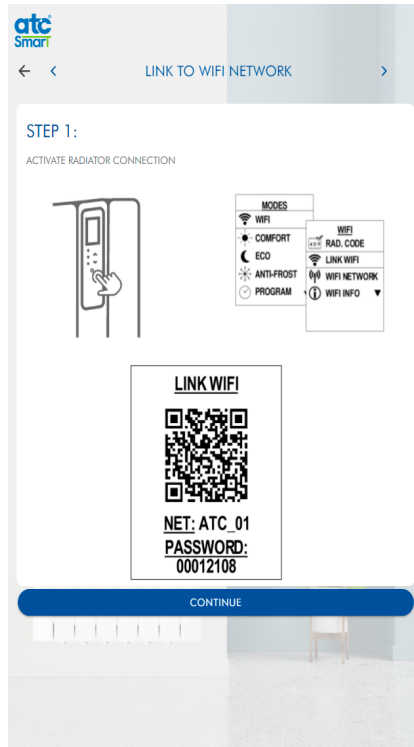

In Step 1, the procedure to activate the inbuilt WiFi is shown on the screen of your mobile device.

In Step 2, either scan the network QR Code with the camera on the Mobile

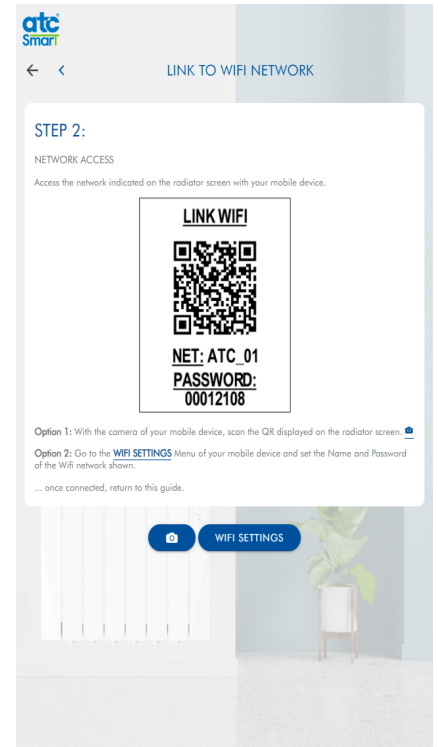

device or select the WiFi settings button and select the "ATC_01" network.

Once the network is selected and connected return to the App.

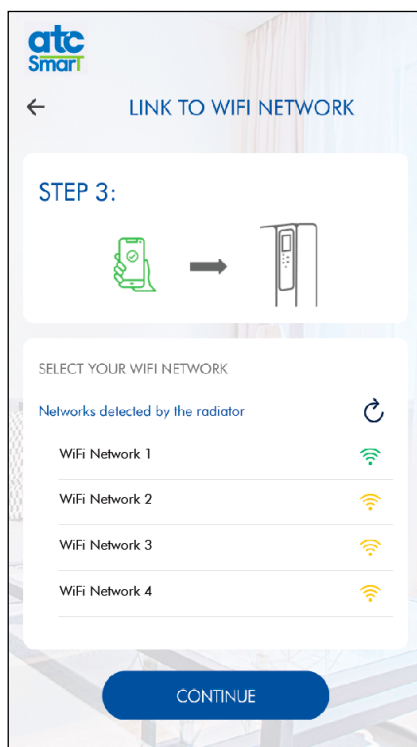

In Step 3, select the WiFi network shown on the screen that the radiator will be connected to. Note that it is only possible to connect to 2.4 GHz Networks which offer greater signal range.

Stronger signal strength is shown in green, weaker signals are yellow and red.

Once the network password information has been entered select continue.

The radiator is now linked to the selected WiFi Network.

5.3.3 Control of the radiator through Virtual Assistants

Once the **ATC CALA** App is installed and a user registered with the App, it is possible to control the App and therefore the iLifestyle WiFi radiators with Amazon Alexa.



Information on the use on this Virtual Assistant with the **ATC CALA** App and the iLifestyle WiFi radiators is available by scanning the following QR code and downloading the instructions.



5.3.4 WiFi Menu

Once the radiator is Operational, in all operating modes except Manual, the “Modes” menu is displayed by touching the **Mode** key once. If the radiator is in Manual mode, touch the **Mode** key twice to access this menu.

In the **Modes** menu, the desired mode is selected with the ▲ and ▼ keys. To select and enter the WiFi menu, touch the ▲ key until you reach the first option, and touch the **OK** key.

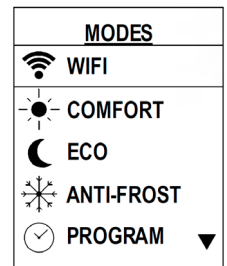

The WiFi menu displays the information required to manage the connection to the WiFi network that the iLifestyle WiFi radiator is connected to.

There are 4 or 5 menus within the WiFi menu depending on whether the radiator has been linked to a WiFi network or not. Each menu item can be selected using the ▼ and ▲ keys and by touching the **OK** key when the required menu is highlighted.

From the WiFi menu, the **Mode** key can be touched to return to the previous operating mode. If no key is touched for 30 seconds, the radiator will also return to the last operating mode.

5.3.4.1 WiFi Radiator Name

At the bottom of the TFT screen of the WiFi menu, the Name assigned to the particular iLifestyle WiFi radiator is shown if it has been registered through the **ATC CALA** App and once it has been connected to a WiFi network. The name can be modified at any time from within the App.

If a WiFi network is linked and connected however no Name appears in the WiFi menu, it means that the radiator is not registered with any user in the App.

Note: The radiator can be unlinked from the WiFi network at any time and then be re-linked to it again or to another network (see next page); in any of these cases, the Radiator Name would continue to be displayed, as it is still registered in the App.

5.3.4.2 WiFi Radiator Code

The Radiator Code is the unique identifier that is required to register the specific radiator in the App. The “RAD. CODE” menu is the first item shown in the WiFi menu.

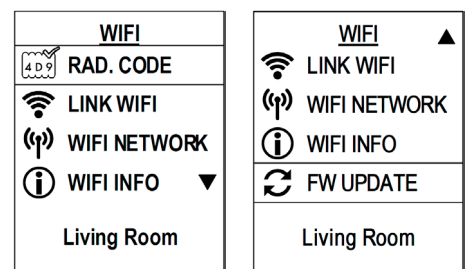

With **RAD CODE** selected touch the **OK** key to display the information screen which contains the radiator code displayed in two ways:

- **A QR Code**, when pairing the Radiator from the App the mobile device’s camera can be used to register the QR Code.
- **A unique 15-Character alphanumeric code** that identifies the radiator that can be typed into the “Device Code” field in the App.



From the “RAD. CODE” screen, if the **OK** or **Mode** key is touched, the radiator will automatically return to the WiFi menu. If no key is touched for 2 minutes, the radiator will return to the last operating mode.

5.3.4.3 Link WiFi

During registration of the **ATC CALA** App the first iLifestyle WiFi radiator is normally linked to the network. When further iLifestyle WiFi radiators are added, they must be linked to a WiFi network to be able to be managed remotely.

First, the radiator’s own WiFi Network must be enabled; from the WiFi menu select the “Link WiFi” option and touch the **OK** key.

- The iLifestyle WiFi radiator will create it’s own WiFi Network and an information screen will appear showing the WiFi Network of the iLifestyle WiFi radiator. The mobile device connects with the WiFi of the radiator (STEP 2 of the Pairing Process) in one of the 2 following ways:

- 1 - Scan the QR directly with the camera of the mobile device.
- 2 - Entering the Network Name and Password shown on the screen:

NETWORK NAME: **ATC_01**
PASSWORD: **00012108**



From the “LINK WiFi” screen, if no key is touched for 5 minutes, the radiator will return to the last operating mode.

Once the connection process with the App has started, and while the Link WiFi screen is active, if an error occurs in the process due to:

- An unexpected interruption of the linking process with the WiFi network.
- An Incorrect WiFi password is entered from the App.
- Manual interruption of the process with the **OK** or **Mode** key.

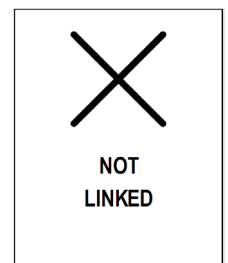

The text “NOT LINKED” appears on the screen and the radiator returns to the WiFi menu.

During the linking process using the App and whilst the Link WiFi screen is active, once the link between the WiFi radiator and the WiFi network is successfully completed the word “LINKED” appears. The Name of the WiFi network is shown on the bottom of the screen.

Once the process is complete, the radiator will return to the last operating mode.

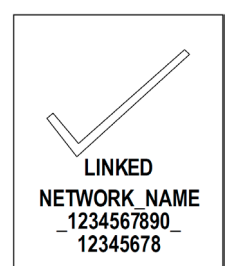

Once the radiator is connected to a WiFi network and for as long as it is connected, the **WiFi symbol** will appear on all operating screens.

5.3.4.4 WiFi Network

This menu will only appear when the WiFi radiator already has been linked to a WiFi network. It will continue to be selectable provided it is linked to a WiFi network.

From this menu screen there are 2 options available, which can be selected with the ▼ and ▲ keys and by touching the **OK** key when the desired option is highlighted.

From the WiFi network menu, you can touch the **Mode** key to return to the WiFi menu. If no key is touched for 30 seconds, the radiator will return to the last operating mode.

1 - DISCONNECT/CONNECT

- Once linked to a WiFi network, the **DISCONNECT** option will appear at the beginning.
- By touching the **OK** key, disconnection of the linked WiFi network will be carried out and the following is shown:
 - The disconnect option will then change to **CONNECT**, you can reconnect to the same network by selecting Connect and touching **OK**.
 - The network connection symbol at the bottom will change its state to crossed out: 

2 - UNLINK WiFi

This option completely disconnects the Radiator from the connected WiFi network. This leaves the radiator without a WiFi network and it can then be added to another different WiFi network. This is also used if there has been an error when linking to the original WiFi network.

Note: To link a new WiFi network (or re-link it to the same one) it is not necessary to unlink it first.

When choosing Unlink WiFi with the **OK** key, the query screen “UNLINK WiFi NETWORK?” will appear with two options, which can be selected with ▲ and ▼, as shown in the image on the right:

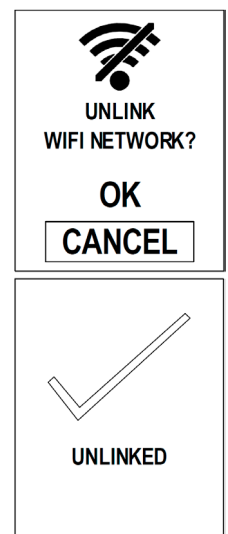

- To exit the screen without unlinking, select the CANCEL option and touch **OK**, the Radiator will then return to the WiFi Network menu.
- To Unlink, select the OK option, touch **OK** and the word “UNLINKED” will appear on the screen, confirming the disconnection. This forgets the WiFi network that the radiator had been linked to and returns to the WiFi Menu. The WiFi Network menu will disappear within the WiFi menu.
- If no key is touched for 30 seconds, the radiator will return to the last operating mode.

The **WiFi Network information** will appear at the bottom of the screen:

- **Network Connection symbol:** Connected  Disconnected 

- **WiFi Symbol:**

The WiFi symbol is shown to the right of the Network Connection symbol. It represents the range or connectivity of the WiFi radiator with respect to its linked WiFi network. It will only appear if the linked WiFi network is actually connected.

The symbol is a copy of the WiFi symbol that appears on the operation screens and only shows once the WiFi network is linked and connected.

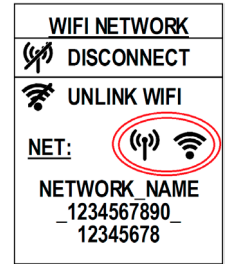

Every time the iLifestyle WiFi radiator sends any data or status to the WiFi network, to be shown in the **ATC CALA** App (e.g.: the initial data at the time it is linked to the WiFi network), as well as each time the network WiFi sends data to the iLifestyle WiFi radiator from the App (e.g.: when it is remotely controlled to change the set point temperature), the WiFi symbol changes to show the sequence below, to confirm correct communication:



When the iLifestyle WiFi radiator is linked to a WiFi network and correctly registered in the **ATC CALA** App, all operational functions as well as their setpoints can be managed directly by the App without having to use the radiator's control panel.

If the radiator has received any change from the App, the TFT screen will not change the level of brightness, nor will it emit any sound, so as not to disturb occupants of the room.

Any changes applied from the App can be overridden or changed directly from the radiator's control panel. This way, in any operating mode, status or configuration applied on the radiator through the control panel, will be displayed in the App. The status of the radiator is updated in both the App and control panel if the connectivity is correct.

When the radiator is operational, it periodically sends its room temperature to the **ATC CALA** App.

In the event that the WiFi network is disconnected or the radiator is without connectivity the radiator will notify that the communication was lost by showing a **crossed out WiFi symbol**:



After reconnecting to the WiFi network or recovering connectivity to it, the iLifestyle WiFi radiator will show a connected WiFi symbol and both the app and radiator be synchronised with the latest information from the **ATC CALA** App or the local control panel. The control panel on the radiator has priority over the information entered from the App.

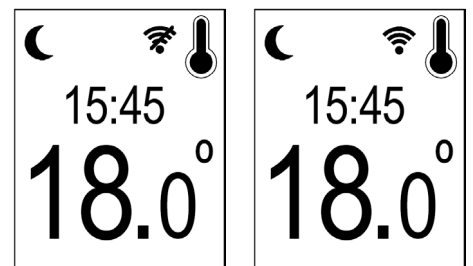

- **Network Name:**

The full name or SSID of the linked WiFi network will appear at the bottom of the WiFi Network menu screen.

This data is used to see which WiFi network the WiFi radiator is linked to in the event of a problem.

5.3.4.5 WiFi Info

This is an information screen which displays the following content:

1. MAC ADDRESS:

Displays the unique MAC address of each radiator provided by the WiFi module.

2. IP ADDRESS:

The following is shown on the screen:

- IP Address of the radiator on the WiFi network to which it is linked.

- OR -

- IP Address “empty” (...) and the text “NO CONNECTION”, when:
 - No WiFi network is linked.
 - There is a linked WiFi network, but it is disconnected.
 - There is a linked WiFi network, but the connectivity is unsuccessful.

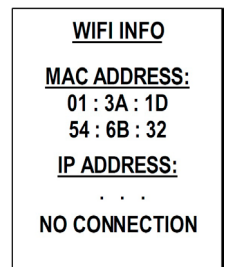
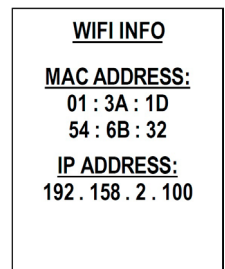

In this information screen, touch the **OK** or **Mode** key to return to the WiFi menu. If no key is touched for 30 seconds, the radiator will return to the last operating mode.

5.3.4.6 Firmware Update

The iLifestyle WiFi radiator allows the remote update of the firmware for the electronics, this is configurable through the last menu within the WiFi menu.

In this menu screen there are 2 options available, select the required option with the ▼ and ▲ keys and touching the **OK** key.

Touch the **Mode** key to return to the WiFi menu. If no key is touched for 30 seconds, the radiator will return to the last operating mode.

Option 1 - AUTO - 02:00 AM

The first option allows disabling or enabling the firmware remote update automatic check for the iLifestyle WiFi electronics; this setting is enabled by default.

When this option is selected, touching the **OK** key will disable or enable the firmware update automatic check.

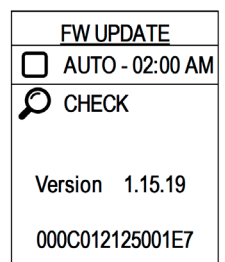
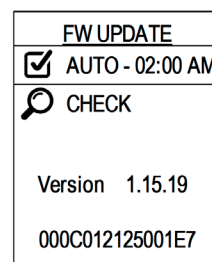

If the option is enabled, the update automatic check will be carried out daily at 02:00 AM. Also with the option enabled, if there is a restart of the WiFi, 10 minutes after the restart the radiator will check if there is a firmware update.

Option 2 - CHECK UPDATES

In addition to the automatic check, it is possible to check if there is any firmware update available, regardless if the automatic check is enabled.

By choosing the second option and touching the **OK** key, the query screen “CHECK UPDATES?” is shown with two options:

- If no key is touched for 30 seconds, the radiator will return to the last operating mode.
- To exit the screen without accepting the action, select **CANCEL** and touch **OK**, the radiator returns to the Firmware Update menu.
- To proceed, select the **OK** option and touch the **OK** key, the “CHECKING FIRMWARE UPDATES...” screen will appear, and search for available firmware updates for the current version of the electronics within the iLifestyle WiFi radiator.

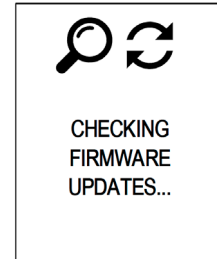
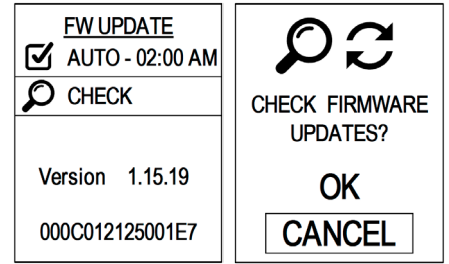

If the update search is run without WiFi network connectivity, either because:

- There is no WiFi network linked.
- The linked WiFi network is disconnected.
- The linked WiFi network is out of connectivity, or too far away.

The search process stops and the “NO CONNECTION” screen is shown, the radiator then returns to the Firmware Update menu.

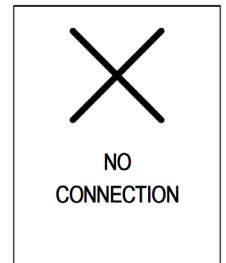

If the radiator is linked to a WiFi network, and it cannot find any upgrades for the current firmware version of the iLifestyle WiFi radiator, the screen “NO FIRMWARE UPDATES FOUND” will appear and the radiator will return to the Firmware Update menu.



If the **Mode** key is touched once the search process has started, the search will stop, and the “NO FIRMWARE UPDATES FOUND” will be shown and the radiator will return to the Firmware Update menu.

If new firmware is found, the data will download and at the end of this process the radiator will update the firmware. The “FIRMWARE UPDATED” screen will be shown and then re-start the WiFi Module with the new firmware version. Once complete the radiator will return to the last operating mode.

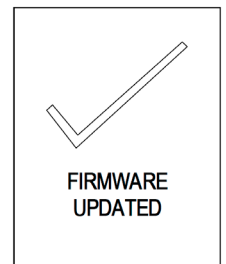

At the bottom of the Firmware Update menu screen, the **current Firmware Version** of the radiator as well as the Radiator Identity Code are shown. If the firmware update is successful the firmware version will be updated with the new version number.

5.4 SELECTING THE OPERATING MODE

In the Modes menu, the desired operation mode can be selected with the **▲** and **▼** keys. Select and enter the operating mode and touch the **OK** key.

The radiator will return to the last operating mode if the **Mode** key is touched, or after 30 seconds without touching any other keys.

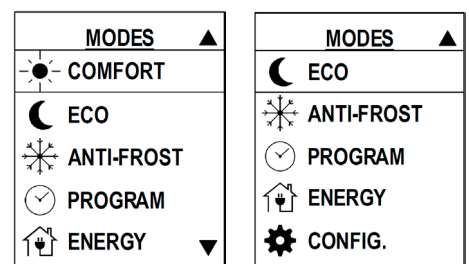

In each of the operating modes the screen will automatically switch the display between the current time and the day of the week.

5.4.1 COMFORT

In Comfort mode the desired room temperature is directly selected using the ▼ and ▲ keys. Available setpoints are **between 12 °C and 30 °C** in steps of 0.5 °C. If the keys are held down, the temperature changes faster. When the temperature reaches either the maximum or minimum value it will stop.

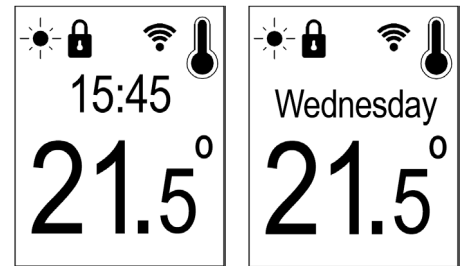

Typical recommended comfort temperature is 20-21.5 °C. The Comfort mode is normally used during the hours the room is occupied.

5.4.2 ECONOMY

In Economy (ECO) mode, the radiator automatically sets a temperature of between 0.5 °C and 4.5 °C less than the comfort temperature (user selectable using the ▼ and ▲ keys). When the comfort temperature is increased or decreased, the ECO temperature will increase or decrease accordingly.

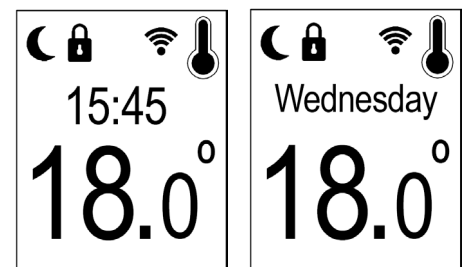

Since the comfort temperature is from 12 °C to 30 °C, the ECO temperature is **from 7.5 °C to 29.5 °C**, but always between 0.5 °C and 4.5 °C below the comfort temperature.

Economy mode is normally used at night or during short periods of absence. It prevents the temperature from dropping too much, as it would be expensive to raise it again.

5.4.3 ANTI-FROST

In Anti-frost mode the temperature is factory set to 7 °C and is not adjustable. Anti-frost mode is normally used as an off set point and for long periods of absence when you want to avoid freezing problems.

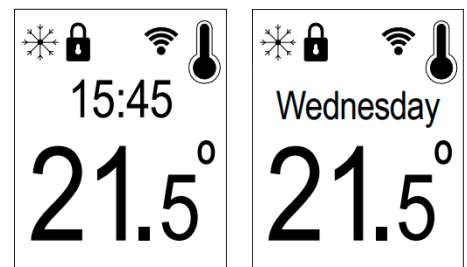

5.4.4 PROGRAM

In Program mode the radiator automatically switches between 3 mode temperatures according to the daily and weekly program set by the user.

The daily program display is divided into two screens: the AM screen from 00:00 to 11:59 and the PM screen from 12:00 to 23:59.

The program is displayed using a circle, which represents an analogue clock face. The screen automatically switches the display between the current time and the day of the week every 5 seconds.

The program screen is shown permanently and displays its particular 12 hour program divided into half-hour intervals; the AM and PM programs will be displayed based on the time of day.

Each half-hour interval of each day of the week can be programmed as:

Comfort, Economy or Anti-frost:

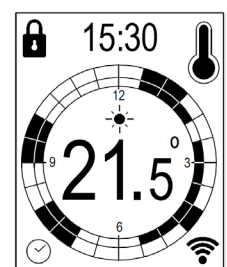
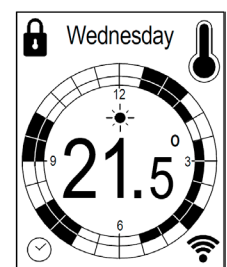

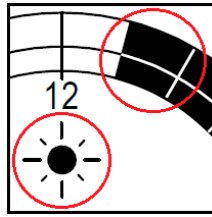

COMFORT

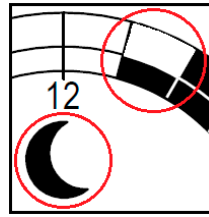

ECO

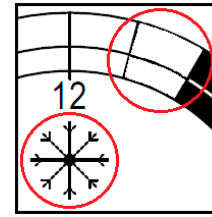

ANTI-FROST

The current half-hour interval flashes to indicate to the user the current set point. Also, the current time operation mode symbol (the Sun, Moon or Frost icon) is displayed in the middle of the screen above the temperature.

In Program mode Comfort and Eco set points can be directly modified with the ▼ and ▲ keys, when their particular mode is active (anti-frost set point can never be modified). When the comfort temperature is increased or decreased, the eco temperature automatically increases or decreases by the same amount.

Adaptive start control can be applied to Program mode and can be disabled or enabled in Configuration mode (see page 31 for details of Adaptive start control function). Program mode is the only mode in which this function operates.

iLifestyle WiFi radiators come with the predetermined program of Anti-frost for all half-hour sections of all days.

EDIT PROGRAM: Selection of the day to be set

In Program mode

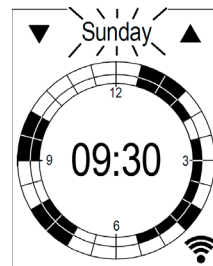
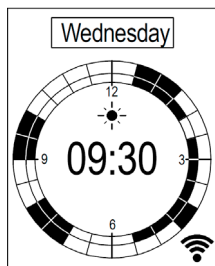

Select the day with



Confirm with



Selecting time and mode (after selecting the day)

Move to the time with

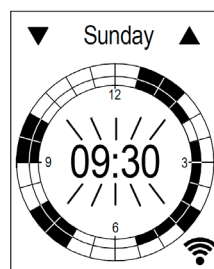
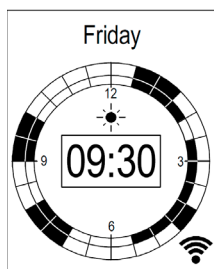

The time can be selected with 1/2 hour intervals.

Select the time with



Confirm with



Select the heating output mode in each time slot:

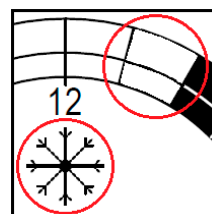
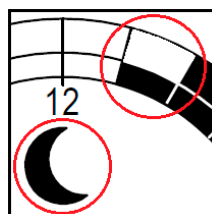
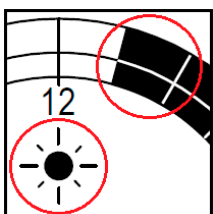

Changes saved

COMFORT

ECO

ANTI-FREEZE

Only select OK after completely programming the entire day

Copy daily programme

If you want to copy the complete program of a particular day to the next day or consecutive days:

Select the day
you want to
copy
with

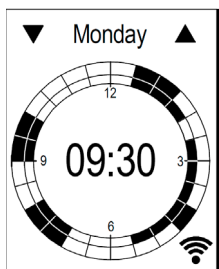

Hold the OK
key



The copied days appear in the succession copying the day forward

Release
the key



To exit and return to the Program mode from the editing screen, touch the  key.

When editing a program, if no keys are touched for 30 seconds, the radiator will return to Program run mode.

5.4.5 ENERGY Menu



This menu registers and displays the electric radiator's estimated energy consumption and its associated estimated cost. It contains 4 types of Energy Meters, each different depending on the selected period of time.

Note: In the ATC GALA App this feature is available but independently of the radiator, the settings on the radiator are not synchronized with the App.

On the main screen there are 3 possible selections, which can be chosen with the ▼ and ▲ keys and selected by touching the **OK** key when the desired menu is highlighted:

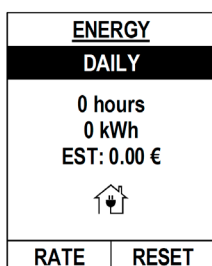

METER TYPE

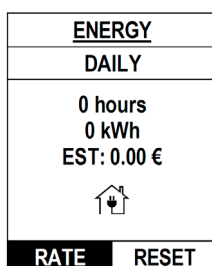

RATE

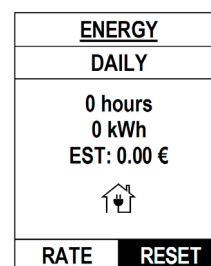

RESET

Whilst in the Energy menu, if the **Mode** key is touched, the radiator will automatically return to the last operating mode. If no key is touched for 30 seconds, the radiator will also return to the last operating mode.

5.4.5.1 Energy Meter Type

This selection is the main part of the Energy menu, where when choosing the type of Energy Meter, all the energy consumption information registered in the corresponding period is displayed underneath it. Select the meter type (as shown above) and touch **OK**.

There are 4 Meter options to select, depending on the time period required:

- **DAILY** - Consumption of the last 24 hours - Updated every hour.
- **WEEKLY** - Consumption of the last 7 days - Updated Daily at 00:00.
- **MONTHLY** - Consumption of the last 30 days - Updated Daily at 00:00.
- **TOTAL** - Total consumption registered, up to 10 years - Updated Daily at 00:00.

To select the type of meter, use the ▼ and ▲ symbols shown beside the time period, each touch of the button will change the display to show the consumption information registered by each meter:

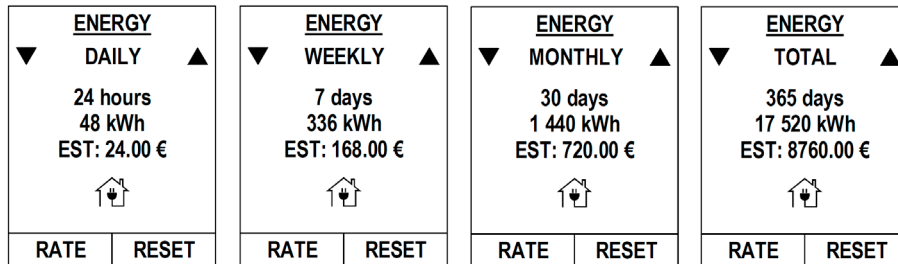

The default meter is the Daily Meter, to set a different meter as default, touch the **OK** key once the required meter is selected. It will save as default and be displayed the next time the meter type menu is entered.

The information shown in each Meter consists of the following:

- **Registered Period:** Number of hours or days (depending on the meter type) that has been recorded
- **Consumed Energy:** Measure of energy consumed in the registered period, in kWh
- **ESTIMATED Cost:** Cost estimated and calculated on the consumed energy, based on the rate applied and configured (see next section)

When the radiator is disconnected from the mains, even if there is no energy consumption (0 kWh), the time period of each meter will continue to count until it has reached the maximum.

If the button cell battery runs out whilst the power supply is disconnected, the meters will stop until the radiator is powered up again (the count will restart if the battery is replaced). The registered values of each meter are not lost unless they are manually reset.

Note: The App will only be able to correctly register the energy consumption that each iLifestyle WiFi radiator sends each hour.

5.4.5.2 Rate

This menu must be initially configured to calculate the estimated cost of the electric radiator's consumption. There are 2 types of rates depending on the time of day:

- Reduced Rate -> Default price: 0.100 €/kWh -> Applied during the configured Period.
- Standard Rate -> Default price: 0.150 €/kWh -> Applied for the rest of the day.

When accessing the Rate menu with the **OK** key, the following screens appear:

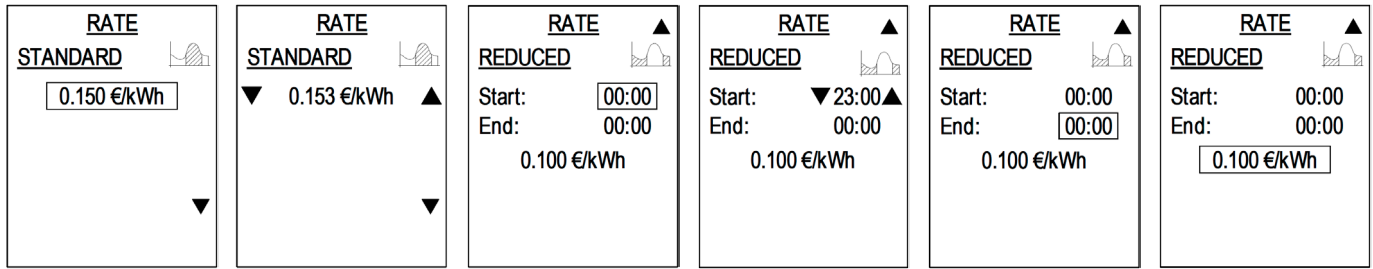

There are 4 options to configure; When ▼ or ▲ is touched, the option changes position and screen depending on whether switching between Standard Rate and Reduced Rate:

- Whenever changing between each of the 4 options, once in the required option, touch **OK**. The symbols ▼ and ▲ will appear at the side of the screen or beside the item to be changed.
- To modify the value, touch the ▲ or ▼ keys. Holding the key down will change the value quickly.

In the Rate menu, if the **Mode** key is touched, the radiator will return to the Energy menu. If no key is touched for 30 seconds, the radiator will return to the last operating mode.

Reduced Rate Configuration:

To set a Reduced Rate, the time period and price must be set.

Reduced Rate Period:

The Reduced Rate applies from **Start Time** to **End Time**. If within the 24-hour period, the Start Time is “later” than the End Time, the entire period possible is applied until the End Time occurs, even if it falls on the next day. For example, it is possible to configure:

Start Time: 23:00
End Time: 06:00

In this example, the duration of the reduced rate would be 7 hours, with the standard rate applicable from 06:00 to 23:00.

To return to a single Standard Rate, set the Start Time and End Time to exactly the same time, either 00:00 (default option), or any other time as long as they are the same.

Reduced Rate price with respect to Standard Rate price.

The Standard Rate price can always be configured or modified. **The price of the Reduced Rate can never be greater than the price of the Standard Rate.**

5.4.5.3 Reset

The last option in the Energy menu is the Reset function, there are 3 menu options, which can be selected with the ▼ and ▲ keys:

Type of METER to Reset // OK / CANCEL

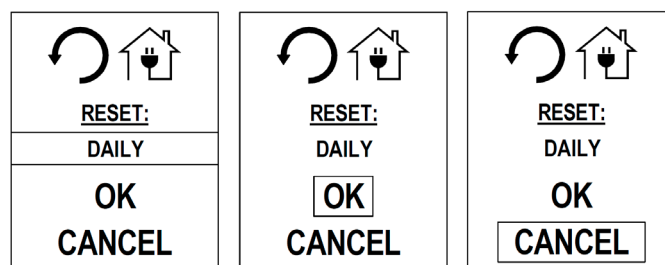

Selecting the “Type of Meter” to reset, shows the DAILY total, however it is possible to select any of the other three available WEEKLY / MONTHLY / TOTAL meters.

When the **OK** key is touched whilst the “Type of Meter” to Reset is selected, use ▲ and ▼ to select which one should be reset. To confirm the selection is correct, touch **OK** again.

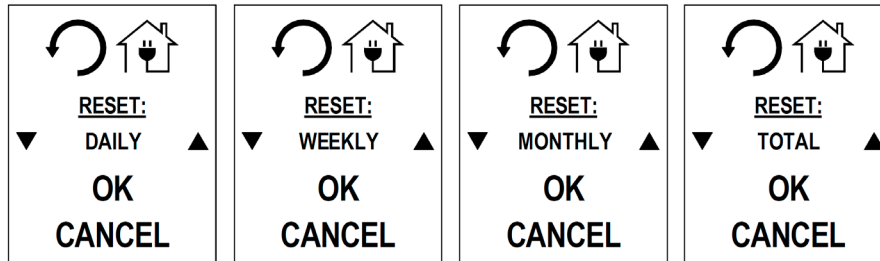

- When the **OK** key is touched while the OK option is selected, it will reset the selected type of meter, as well as the meters with a period less than the one selected. i.e. Selecting Monthly, will reset Monthly, Weekly and Daily.

When the meter or meters are reset, all the energy consumption values will be reset to 0:

Registered Period: 0 days / 0 hours
 Consumed Energy: 0 kWh
 Estimated Cost: 0 €

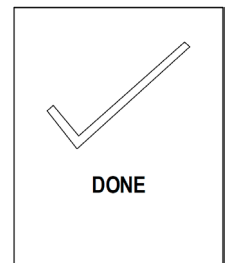

“DONE” will appear on the screen, confirming the meter reset.

- Touching the **OK** key with CANCEL selected, will return to the Energy menu.

In the Reset menu, touching the **Mode** key will automatically return to the Energy menu. If no key is touched for 30 seconds, the radiator will return to the last operating mode.

5.4.6 CONFIGURATION Menu

Configuration menu allows the user to set parameters and functions for the other modes.

There are 9 menus in Configuration menu which can be selected by ▼ and ▲ keys, and touching the **OK** key when the desired menu is highlighted.

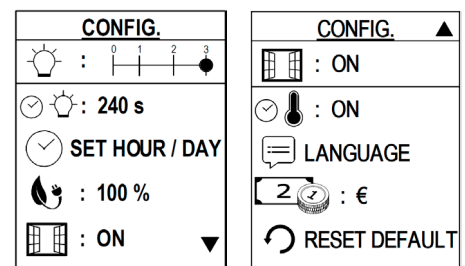

When finished, the **Mode** key can be touched to return to the previous mode. When no keys are touched for 30 seconds, the radiator will return to the previous operation mode.

5.4.6.1 Brightness level at rest

This menu sets the level of brightness that the radiator will show when it is at rest; this is the brightness level of the screen kept after the time selected in menu 2.

There are 4 levels to choose from:

- 0: Off.
- 1: 25 % brightness.
- 2: 65 % brightness.
- 3: 100 % brightness.
(this is the level when any key is touched)

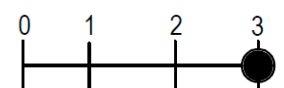

The level can be adjusted using the ▲ and ▼ keys and confirmed with the **OK** key; the radiator

will then return to the Configuration screen.

5.4.6.2 Maximum brightness Time

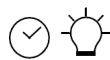

This menu sets the time (in seconds) that the radiator screen is at 100 % brightness, from the time that the last key is touched, before going to rest.

The time value can be changed between **1 and 240 seconds**. The time can be adjusted using the ▲ and ▼ keys; if the keys are held then the time changes faster. Confirm the selection by touching the **OK** key; the radiator will then return to the Configuration screen.

5.4.6.3 Setting the time

This menu is used to initially set the time and day, and also to change the time if required, for example, during daylight saving.

Use the ▲ and ▼ keys to select either the day of the week, or (if the day is correct) the time to be modified. Touch **OK** to enter the desired section to change.

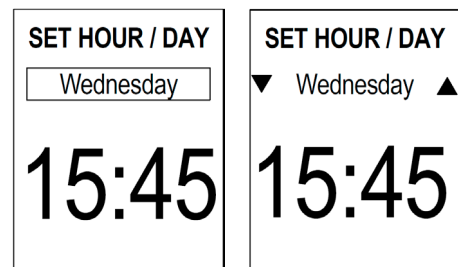

Select the day with the ▲ and ▼ keys; you can choose from Monday to Sunday and confirm the correct day by touching **OK**.

When setting the time, the setting starts with the hour; select from 00 to 23 using the ▲ and ▼ keys. Once the hour is correct, touch the **OK** key; the radiator will change to set the minutes, selecting from 00 to 59 using the ▲ and ▼ keys and confirm by touching **OK**.

To go back to the Configuration screen, touch the **Mode** key at any time.

Daylight saving time will need to be manually changed.

When the button cell battery life ends (see page 12), and after a power failure or disconnection from the mains the radiator will request the user to set the hour/day, as the system clock is reset to Monday 00:00.

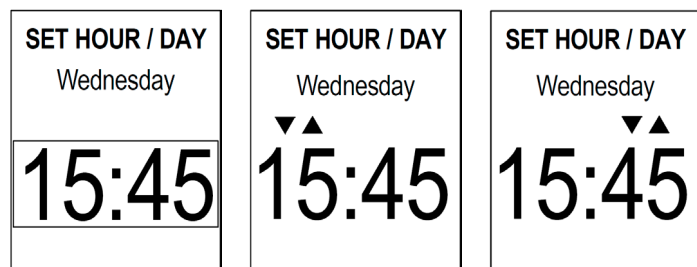

The battery icon will flash until the hour/day is set.

After 30 seconds the radiator will choose Monday and 00:00 as the day and time and will return to the last used mode of operation.

The radiator will request the time to be set each time there is a power disconnection or until the button cell is replaced.

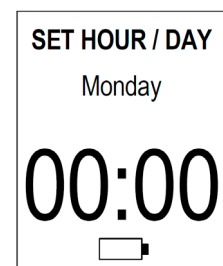

Note: It is not necessary to use this menu when the radiator is linked to a WiFi network as it will automatically obtain the correct updated time. If the iLifestyle WiFi radiator is registered in the ATC CALA App, the time will be updated to the Time zone of the Installation in which the radiator is installed.

5.4.6.4 Power Limitation

This function allows the reduction of the radiator's average consumption **manually**. If there is a radiator with a specific output for a room with a particular volume (m³), it can be set to use less power if it is used in a smaller room that has less volume.

The value will be a percentage of the full power of the radiator with regard to its normal full value:

- **Maximum value: 100 %** (default value of the radiator)
- Minimum value: **20 %**
- Steps: **5 %**

Example: Consumption in one hour:

Radiator 1000 W -> PL value = 100 %-> Consumption: 1000 Watts (Full Consumption)
 Radiator 1000 W -> PL value = 80 %-> Consumption: 800 Watts (Reduced Consumption)

The specific Power Limit value can be decreased or increased with the ▼ or ▲ keys. When the desired value has been set confirm with the **OK** key; the radiator will then return to the Configuration screen.

5.4.6.5 Open Window

This menu disables/enables the Open Window function (see page 30 of this manual). Select OFF/ON with the ▼ and ▲ keys and confirm with the **OK** key; the radiator will return to the Configuration screen after the selection is made.

5.4.6.6 Adaptive start control

This menu disables/enables the Adaptive start control function (see page 31 of this manual). Select OFF/ON with the ▼ and ▲ keys and confirm with the **OK** key; the radiator will return to the Configuration screen after the selection is made.

5.4.6.7 Language

This menu is used to set the display language on the screens:

- SPANISH
- ENGLISH

Select the preferred language with the ▲ and ▼ keys, and confirm with the **OK** key. The radiator will update the language of all screens.

<u>LANGUAGE</u>
ESPAÑOL
ENGLISH

5.4.6.8 Currency

Currency type to be used for data and settings of the Energy menu:

Euro (€) / Pound sterling (£)

Select the preferred currency with the ▲ and ▼ keys, and confirm with the **OK** key; the radiator will return to the Configuration screen after the selection is made.

5.4.6.9 Reset factory defaults

This menu is used to reset the radiator back to the default factory settings:

- **The radiator is unlinked from the WiFi network, its Name is removed from the screen and in the ATC CALA App it is removed from the user account to which it was registered,**
- Comfort set point is 20 °C,
- Economy set point is 16.5 °C,
- The Program is set to Anti-frost for all half-hour sections of all days,
- The 4 Energy Meters are reset to 0,
- The Rates configuration returns to the default values (page 24),
- The day is set to Monday,
- The time is set to 00:00,
- Brightness level at rest is set to 1,
- Maximum brightness Time is set to 10 seconds,
- Power Limitation is set to 100 %,
- Open Window and Adaptive start control are enabled,
- The language is set to English,
- The currency is set to €,
- **The radiator automatically returns to Standby mode.**

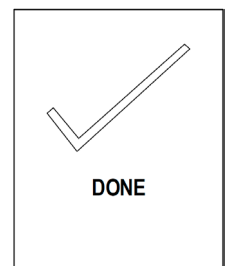
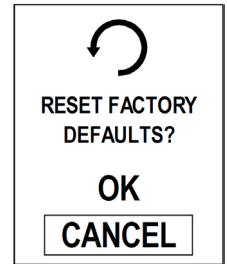

5.5 HEATING AND TEMPERATURE DISPLAY

When the room temperature is below the temperature set point, the radiator will turn the element on to raise the room temperature. To show the user that the radiator is heating there is an icon of a thermometer being filled on the top right hand corner of the TFT screen:



The room temperature is normally displayed on the TFT screen. The set point temperature is only displayed when the user attempts to change it; after the setting has been adjusted the display will revert back to the room temperature.

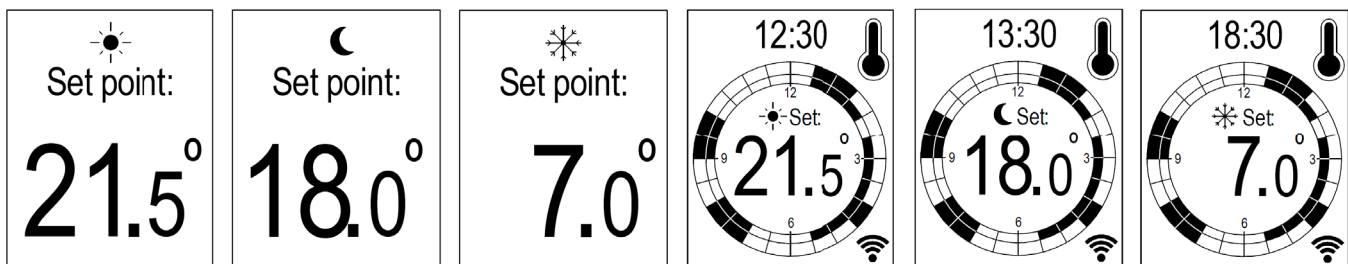

The comfort and eco set point temperatures can be modified both from Comfort and Economy modes, and also within Program mode if they are active at the time (the anti-frost set point can never be modified).

5.6 MANUAL MODE

The Manual mode is designed to allow a user to override the Program mode without having to change the program itself. For example, if you arrive when the radiator is normally unheated, you can heat the space to a comfortable temperature and then ensure that the radiator returns to its normal mode without changing the program.

It allows the user to manually operate the radiator and override the current setting. It is able to force the radiator to heat or not for a set amount of time. After the time expires, the radiator will return to the previous mode of operation.

To enter Manual mode, touch the **suitcase key** and then use the ▲ and ▼ keys to enter the amount of time you want to force the radiator to heat or not.

Firstly, the number of days is selected; enter between 0 and 365 days and confirm using the **OK** key. If you only want a few hours, touch **OK** to enter 0 days.

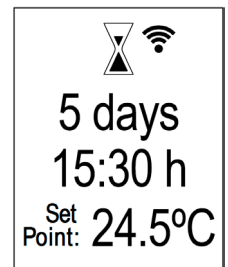

The menu then moves to the number of hours selection. The user is able to enter the amount of time to operate in 1 minute increments up to 1 hour, after which time the steps increase to 30 minute increments. When the total desired time is entered, confirm with the **OK** key.

Please note the default minimum time is 30 minutes, however this can be decreased using the ▼ key.

Finally, the desired temperature can be set by the ▼ and ▲ keys; any temperature between 7 °C and 30 °C (in steps of 0.5 °C) can be entered. Unheated mode can be entered from either 7 °C or 30 °C by touching the ▼ or ▲ keys once from each extreme. Unheated mode is displayed with 4 dashes on the screen (- - - -). When the desired temperature is entered confirm with the **OK** key. The screen will display “DONE”.

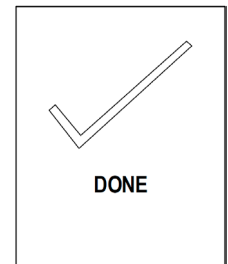
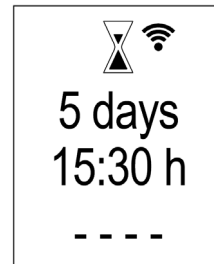

If no key is touched within 30 seconds before final confirmation, or the **Mode** key is touched, the radiator will return to the previous mode of operation.

The selected time will remain on the display and count down until it is finished. Although the set time cannot be changed, it is possible to change the set point temperature during the operation of Manual mode using the ▼ and ▲ keys.

Once the set time has elapsed, the radiator will automatically return to the previous mode of operation.

To exit Manual mode at any time, touch the **Mode** key and the radiator will return to the previous mode of operation.

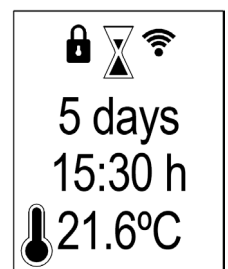

In the case where the power is disconnected to the radiator, the Manual mode settings will be saved, and the remaining time will count down even though the radiator is powered-off.

5.7 OPEN WINDOW FUNCTION

When the Open Window function is enabled in the Configuration menu the radiator automatically stops heating when it detects a sudden drop in the temperature (4 °C in 20 minutes). This is normally caused when a window or door is opened to the outside without turning off the radiator. When the Open Window function has been activated, it will be shown on the display by a single screen with an open window.

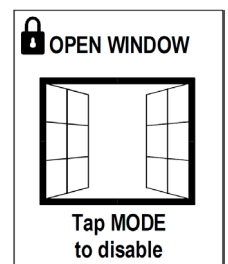

In order to enable the heating again, the user must touch the **Mode** key. The radiator will then return to the previous mode of operation.

Note: In installations where this function is activated very frequently, it may be appropriate to keep it disabled.

* This function is considered by Directive 2009/125/EC regulations and will give the unit more efficiency during operation.

5.8 ADAPTIVE START CONTROL FUNCTION

When the Adaptive start control function is enabled in the Configuration menu, the radiator automatically starts heating prior to the programmed time (a maximum of 2 hours before), to ensure that the next “on” set point is reached efficiently.

The radiator analyses the next two hours, and if there is a set point higher than the current room temperature within that period, and knowing the heating speed of the unit, the software calculates when it needs to start heating. This calculation is made every 5 minutes.

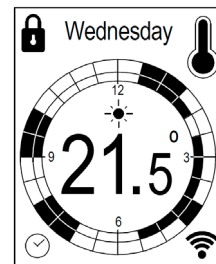

This function only runs when the radiator is in Program mode. When Adaptive start is running, a flashing clock icon is displayed next to the thermometer icon. This function will only operate on temperature rise, e.g., from anti-frost to eco / comfort, or from eco to comfort.

When Adaptive start is running, the radiator progressively increases the set point temperature until the next programmed set point is reached.

* This function is considered by Directive 2009/125/EC regulations and will give the unit more efficiency during operation.

5.9 KEYBOARD LOCK

The user can lock the radiator keyboard by touching and holding the ▲ and ▼ keys down together for 2.5 seconds; the keyboard can be unlocked in the same way.

When the keyboard is locked or unlocked, the screens on the right are displayed.

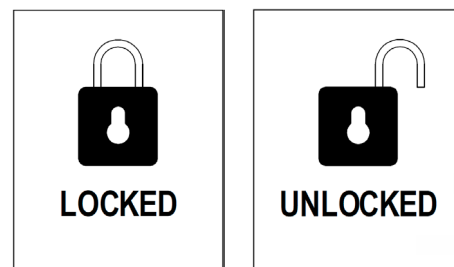

When the radiator is locked, the padlock icon will appear in the upper area of the screen. It is possible to lock the radiator in all modes, even Standby mode.

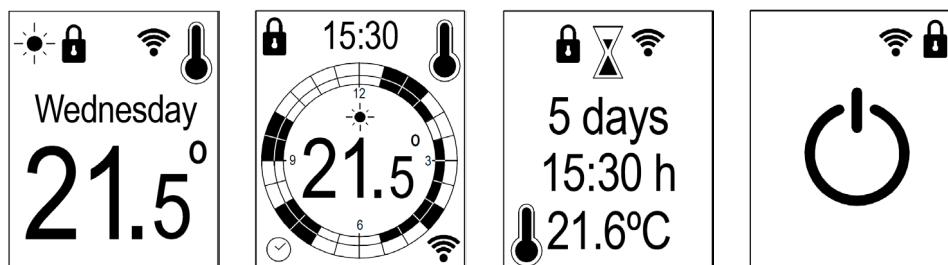

Note: The keyboard lock and unlock actions can also be performed from the ATC CALA App if the radiator is linked to a WiFi network.

5.10 INTERNAL PARAMETERS CONFIGURATION

There are two user configurable internal parameters in the iLifestyle WiFi radiator. By design they are not meant to be changed often.

Although both are internal parameters of the radiator, they can also be configured through the **ATC CALA** App if the radiator is connected to an account.

To access the parameter selection menu, touch and hold the **OK** and **Mode** keys for 5 seconds until the menu appears on the display.

There are two fixed values on the screen that cannot be modified:

- The first line shows the **Firmware Version** of the radiator.
- The last line, at the bottom, shows the **radiator Code**.

Version	1.15.19
Param.0	100
Param.1	-1.5
Param.2	1P
000C012125001E7	

This information may be required if you need to contact technical support regarding your radiator. They are not user-adjustable values and are only shown for information.

Param. 0: Internal Parameter 0

The first line is parameter 0, this is an internal production parameter which is set on manufacture of the radiator. **Under no circumstances should it ever be modified.**

Touching **OK** key with parameter 0 flashing will move to the first adjustable parameter.

Param. 1: Temperature Offset

The first user adjustable parameter on the menu is the **temperature sensor probe correction setting**. Adjustment of this value is used in case the temperature measurement shown on the display of the radiator is very different from temperature measurements in the space.

For example, the radiator stops heating before the actual room temperature reaches the selected set point temperature of 21 °C; the radiator stops when the actual room temperature is only 19 °C. As the actual room temperature remains 2 °C below the set point, a value of -2.0 should be entered to the incorrect measurement shown on the display.

The probe correction value is set using the ▲ and ▼ keys, in steps of 0.1 °C. The value can range from -5 °C to + 5 °C. Confirm the set point by touching the **OK** key. The menu will then move to the second parameter.

Param. 2: Easy Mode

The second user adjustable parameter on the menu allows the selection of an “Easy Control” way to control the radiator.

1P: 1P is the default value (Normal Mode) and will allow full control over all the features of the radiator. All the functions detailed in this manual are available in 1P.

2P: 2P will enable EASY MODE (page 33); this is the easiest way to control the radiator.

Select either 1P or 2P using the ▲ and ▼ keys, and confirm by touching the **OK** key. Touching the **OK** key in this last parameter will exit the Internal Parameters Configuration into the selected Mode (1P or 2P).

During the configuration of the internal parameters, if no key is touched for 30 seconds, the radiator will return to the previous mode of operation.

5.11 EASY MODE

Once the radiator is set into the Easy Mode, it will only allow the user to increase and decrease the temperature setting or set the radiator operational and standby.

There is no access to the clock, mode or configuration changes and no keyboard lock, just the heating icon showing if the radiator is currently heating, the current room temperature and the WiFi symbol showing if the radiator has a WiFi network linked or not.

Only the **Standby**, ▲ and ▼ keys are operational.

The configuration values are set as shown below and cannot be modified in Easy Mode:

- 1 - Brightness level at rest: *Level set in 1P (Normal Mode)*.
- 2 - Maximum brightness Time: *Time set in 1P (Normal Mode)*.
- 3 - Open Window: OFF.

To modify the brightness values used by the radiator in Easy Mode (2P), they must be previously set in Normal Mode (1P). The Open Window function will always be disabled in Easy Mode, regardless of its setting in Normal Mode.

The radiator temperature set point is adjustable with the ▲ and ▼ keys between 12 °C and 30 °C, in steps of 0.5 °C.

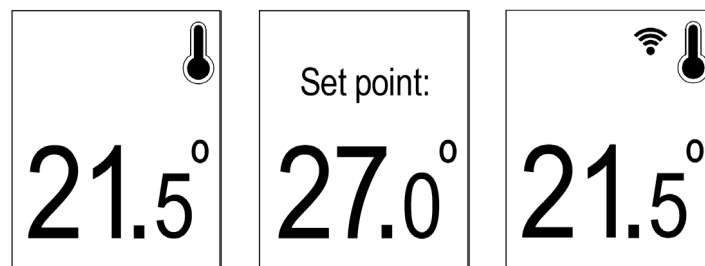

If the radiator is set into the Easy Mode without having been linked to a WiFi network, it will not be able to be linked until it is set into the Normal Mode again and then follow the required steps.

Once the iLifestyle WiFi radiator has been linked to a WiFi network, it can be set into the Easy Mode and then be remotely controlled using the **ATC CALA** App, but with the simple control options outlined previously.

Through the App, the iLifestyle WiFi radiator can be set in Normal Mode or Easy Mode at any time.

Note:

When remotely controlling a radiator in Easy Mode by the **ATC CALA** App, its brightness level at rest and its maximum brightness time can be directly configured, without previously setting it in Normal Mode.

The new configured values will be used if returning the radiator to Normal Mode.

6. ERROR CODE INFORMATION

There are 4 possible errors that the electronics of the iLifestyle WiFi radiator can detect; if an error is detected, one of the following codes will be displayed on the screen until it is resolved:

ERROR CODE	DESCRIPTION
ERROR1	Failure in microcontroller, EPROM or other PCB component
ERROR2	Failure of the NTC probe (e.g. disconnected, short-circuited, etc.)
E3 (Flashing symbol)	Failure in the WiFi module (damaged module)
E4 (Flashing symbol)	Continuous failure over time in the WiFi communication

When recovering from error 1 or 2, the radiator will always go to Standby mode, without retaining any previous mode or state. If the radiator goes to Standby without any specific reason, it may have recovered from either error 1 or 2.

Errors 1 and 3 require the replacement of the electronics, as there is a problem with a PCB component. Error 2 requires the replacement of the NTC temperature probe.

Errors 3 and 4 (E3 and E4) are failures related with the WiFi communication. Both errors are simply displayed with “E3” or “E4” on the location of the WiFi symbol.

Although the radiator can immediately detect error 3, whether linked to a WiFi network or not, error 4 can only be detected when the radiator is linked to a WiFi network.

Error 4 is shown by a radiator linked to a WiFi network when detecting a WiFi communication problem (displaying the crossed out WiFi symbol), that persists for at least 24 hours from when the issue is first detected. Then, the crossed out WiFi symbol changes into “E4”:



When error 4 is detected, the iLifestyle WiFi radiator automatically enters Standby for security reasons; however, it can then be returned to Operational again and be controlled with its control panel but without communication until the error is resolved.

If the radiator is set to Operational through its control panel but error 4 is not resolved, after 24 hours without touching the keyboard, it will return to Standby again until the error is resolved or the radiator is unlinked from its WiFi network.

If error 4 was due to a WiFi network outage or range issue, the error may be resolved by restoring connectivity to the entire system and at the correct distances between the router and the radiator. In this case, the connected WiFi symbol will be displayed. If however the problem persists with the entire system connected at the correct distance, the electronics should be replaced.

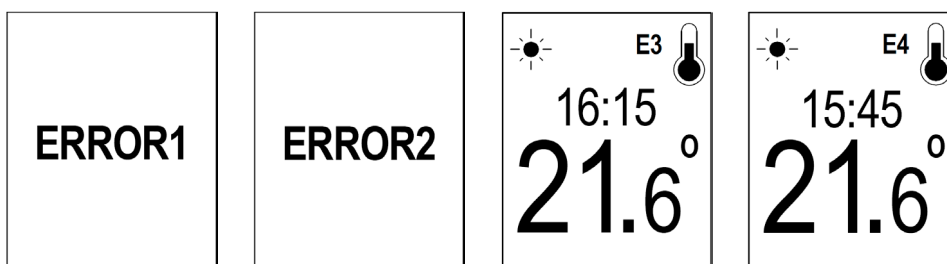

7. MAINTENANCE AND CARE

iLifestyle WiFi radiators require very little maintenance. In order to clean the radiator, it is recommended that the electric power is switched off. Wipe the outside of the product and clean the inside channels with an appropriate brush. **Do not insert fingers the inside channels.**

The surfaces of the radiator must not be cleaned with an abrasive product or those containing granular substances. We recommend regular cleaning with PH neutral products.

Failure to keep the iLifestyle WiFi radiator clean may result in dust becoming burnt and depositing on the wall above the radiator in the form of dark streaks or patches. This type of marking is expressly due to failure to keep the radiator and surrounding area clean.

ATC take no responsibility for any such damage caused.

The radiator should not be covered at any time; however, if the radiator is covered by wet clothes, it is possible for dye to stain the surfaces of the radiator. Check the labelling on the clothing for advice should this situation occur.

8. CHARACTERISTICS TABLE

Model	No. of elements	Power (W)	A (mm)	Weight (kg)	Voltage	Mains connection	Class	IP Code	RF Band (MHz)	Type
iLifestyle Wifi 500	3	500	396	6.4	230 V 50 Hz	FIXED WIRING	I	IP24	2412 ~ 2484	FLUID
iLifestyle Wifi 750	5	750	556	9.2						
iLifestyle Wifi 1000	6	1000	636	10.7						
iLifestyle Wifi 1200	7	1200	716	12.0						
iLifestyle Wifi 1500	9	1500	876	14.8						
iLifestyle Wifi 1800	11	1800	1036	17.7						

Maximum RF power transmitted in the RF Band of operation: 0.1 W

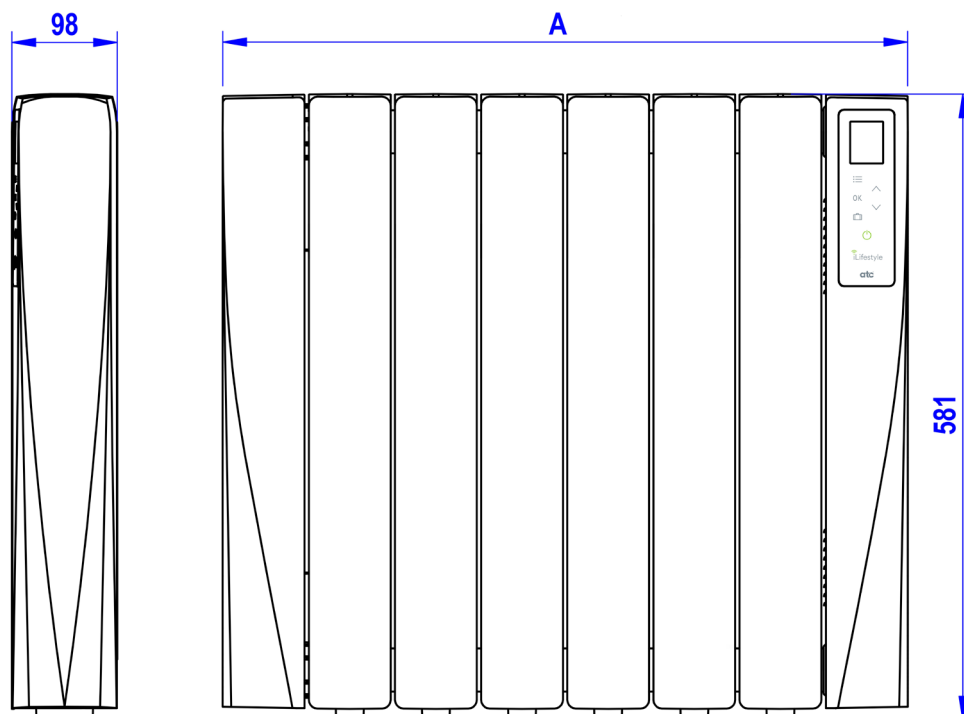

11. CE DECLARATION OF CONFORMITY



ATC House
Head Office & Energy Showrooms
Broomhill Drive, Tallaght
Dublin, D24 EF99

Declaration of Conformity

We, the undersigned, certify and declare under our sole responsibility that the product designated in this Declaration complies with the following specifications and bears the CE mark above in accordance with the provisions the following specifications:

The products described below are in conformity with the relevant Union harmonization legislation:

2014/35/EU – LVD Directive
2014/30/EU – EMCD Directive
2014/53/EU – RED Directive
2009/125/EC – ERP (Ecodesign) Directive
(EU) 2024/1103 – ERP (Ecodesign) Commission Regulation 2
012/19/EU – WEEE 2011/65/EU and (EU) 2015/863 – RoHS Directives
(EC) No 1907/2006 – REACH Regulation

The relevant harmonized standards, or the technical specifications, in relation to which conformity is declared, that have been applied are:

EN IEC 60335-1:2023 + A11:2023
EN 60335-2-30:2009 + AC:2010 + A11:2012 + AC:2014 + A1:2020 + A12:2020 + A2:2022 + A13:2022
EN 62233:2008 + AC:2008
EN IEC 55014-1:2021
EN IEC 55014-2:2021
EN IEC 61000-3-2:2019 + A1:2021 + A2:2024
EN 61000-3-3:2013 + A1:2019 + A2:2021 + AC:2022-01
EN 301 489-1 - V2.2.3 (2019-11)
EN 301 489-17 - V3.3.1 (2024-09)
EN IEC 63000:2018

Applicant: ATC
Address: ATC House,
Broomhill Drive,
Tallaght,
Dublin 24
Declaration Product: Oil Filled Radiator
Product Name/Code: iLifestyle WiFi
WLS500, WLS750, WLS1000, WLS1200, WLS1500, WLS1800
Issue Date: 27th May 2025

Any change to the appliance and/or any use not according to the instructions will lead to the invalidation of this declaration of conformity

Manufacturer/Importer
ATC
ATC House
Broomhill Drive
Tallaght
D24 EF99

Approved By



Company Director

12. UKCA DECLARATION OF CONFORMITY



ATC House
Head Office & Energy Showrooms
Broomhill Drive, Tallaght
Dublin, D24 EF99

Declaration of Conformity

We, the undersigned, certify and declare under our sole responsibility that the product designated in this Declaration complies with the following specifications and bears the UKCA mark above in accordance with the provisions the following specifications:

The products described below are in conformity with the relevant Union harmonization legislation:

2016 No. 1101 – Electrical Equipment (Safety) Regulations
2016 No. 1091 – EMC Regulations
2017 No. 1206 – Radio Equipment Regulations
2010 No. 2617 – Ecodesign for ERP Regulations
2013 No. 3113 – WEEE Regulations
2012 No. 3032 – RoHS Regulations
2008 No. 2852 – REACH Enforcement Regulations

The relevant harmonized standards, or the technical specifications, in relation to which conformity is declared, that have been applied are:

BS EN IEC 60335-1:2023 + A11:2023
BS EN 60335-2-30:2009 + A13:2022
BS EN 62233:2008
BS EN IEC 55014-1:2021
BS EN IEC 55014-2:2021
BS EN IEC 61000-3-2:2019 + A2:2024
BS EN 61000-3-3:2013 + A2:2021
EN 301 489-1 - V2.2.3 (2019-11)
EN 301 489-17 - V3.3.1 (2024-09)
BS EN IEC 63000:2018

Applicant: ATC
Address: ATC House,
Broomhill Drive,
Tallaght,
Dublin 24
Declaration Product: Oil Filled Radiator
Product Name/Code: iLifestyle WiFi
WLS500, WLS750, WLS1000, WLS1200, WLS1500, WLS1800
Issue Date: 27th May 2025

Any change to the appliance and/or any use not according to the instructions will lead to the invalidation of this declaration of conformity

Manufacturer/Importer
ATC
ATC House
Broomhill Drive
Tallaght
D24 EF99

Approved By



Company Director

13. WARRANTY

USER
Name
Address

SELLER
Name
Address

Date of sale

Stamp and signature of the distributor

WARRANTY CERTIFICATE

GUARANTEE: **ATC** with address: ATC House, Broomhill Drive, D24 EF99, Tallaght, IRELAND
PRODUCT: This warranty is applicable to the products contained in this manual
WARRANTY: 24 months from Date of Purchase (Proof of sale required)

ATC assures the electronics in the control panel have a warranty of 2 years from the date of purchase.
ATC assures the aluminium elements that make up the radiator body are guaranteed 10 years.

Unless proven otherwise, it shall be presumed that if not shown within six months of delivery that the product was fine when delivered.

There is a parts warranty of two years from the date of delivery of the appliance, apart from the aluminium frame which is guaranteed for ten years.

This warranty applies, only and exclusively, to equipment sold and installed in Ireland and the United Kingdom. Repairs will be carried out in the workshops of ATC or its nominated agent.

The material replaced in warranty becomes property of ATC.

Should any item be replaced under warranty, the only warranty on the replaced item is the remainder of the original warranty.

SCOPE OF WARRANTY

Unless there are event(s) or object(s) that prove to the opposite, it will be assumed that the products acquired are suitable and good for the purpose that it is purchased for and that always happens under the following conditions:

- The guaranteed unit shall correspond to the manufacturer intended exclusively for Ireland and the United Kingdom and should be installed in Ireland and the United Kingdom.
- The spare parts which are necessary to be replaced, will be determined by our qualified service and in all cases, shall be original products from the manufacturer.
- The warranty is valid provided that normal maintenance operations described above in the technical instructions provided with the equipment have been carried out.
- The consumer must inform ATC of the lack of conformity of the goods, in a period of less than two months since they learned of it.

The warranty does not cover incidents caused by:

- The power supply of insufficient capacity or equipment used with generators or any other system that is not a stable power supply.
- Products whose repairs have not been conducted by ATC qualified service personnel or their authorized agents.
- Corrosion, deformation, etc., caused by improper storage or installation.
- Handling of the product by other personnel not employed by ATC during the warranty period.
- Installation not in accordance with the instructions provided in the equipment.
- Installation of equipment by unqualified personnel.
- Defects in electrical, hydraulic facilities, or by lack of flow, etc.
- Defects caused by improper treatment.
- Anomalies caused by atmospheric agents (ice, lightning, flooding, etc.) as well as erratic current or voltages.
- Improper maintenance, neglect or misuse.
- **Damages caused to premises caused by lack of cleaning of the radiator (e.g. black streaks on walls).**

Transport damages must be claimed by the user directly from the carrier.

VERY IMPORTANT: Radiators must be correctly sized for each room they are to heat. There is sizing information available on the website www.atc.ie. Draughty and badly insulated rooms will cause the radiator to use more power to reach the set temperature. Undersized radiators may not reach the set temperature and are costly to run.

To claim on the warranty here recognized, it will be required that the appliance is used as intended for household and commercial use only. Also, it will be necessary to deliver the radiator to the technical personnel of ATC at their premises or the premises of their nominated agent. A clear and legible copy of the invoice or receipt for the radiator together with the delivery slip must be supplied.

This warranty is in addition to any statutory rights.

14. CORRECT DISPOSAL OF THIS PRODUCT

(Waste Electrical & Electronic Equipment)

(Applicable in the European Union and other European countries with separate collection systems)

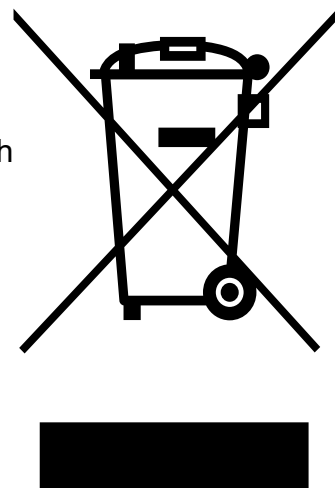

This marking shown on the product or its literature, indicates that it must not be disposed of with other household wastes at the end of its working life.

To prevent possible harm to the environment or human health from uncontrolled waste disposal, please separate this from other types of wastes and recycle it responsibly to promote the sustainable reuse of material resources.

Household users should contact either the retailer where they purchased this product, or their local government office, for details of where and how they can take this item for environmentally safe recycling.

Business users should contact their supplier and check the terms and conditions of the purchase contract. This product must not be mixed with other commercial wastes for disposal.



ATC Electrical and Mechanical
ATC House
Broomhill Drive
D24 EF99, Tallaght, IRELAND
www.atc.ie www.atcelec.co.uk

MADE IN SPAIN